

## AFBR-S4N66P024M

### 2x1 NUV-MT Silicon Photomultiplier Array

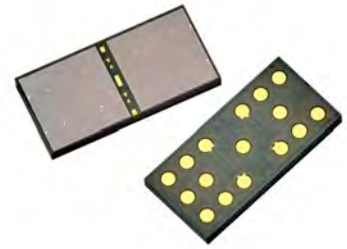

### Description

The Broadcom<sup>®</sup> AFBR-S4N66P024M is a Silicon Photomultiplier (SiPM) array used for ultra-sensitive precision measurements of single photons. Two 6 mm × 6 mm SiPMs are arranged in a 2x1 element array with a pitch of 7 mm. Larger areas can be covered with a SiPM-pitch of 7 mm by tiling multiple AFBR-S4N66P024M arrays. The passivation layer is a clear epoxy mold compound (EMC) highly transparent down to UV wavelengths. This results in a broad response in the visible light spectrum with high sensitivity towards blue and near-UV region of the light spectrum. The array is best suited for the detection of low-level pulsed light sources, especially for detection of Cherenkov or scintillation light from the most common organic (plastic) and inorganic scintillator materials (for example, LSO, LYSO, BGO, NaI, CsI, BaF, LaBr). This product is lead-free and RoHS compliant.

### Block Diagram

Figure 1: AFBR-S4N66P024M Block Diagram of Single SiPM Element

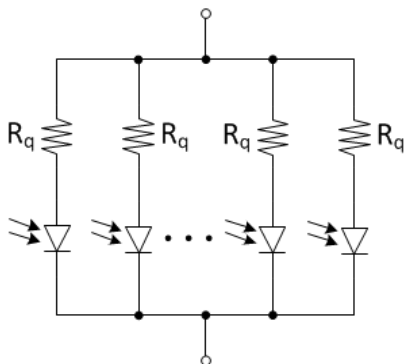

### Features

- 2x1 SiPM array
- Array size 13.54 mm × 6.54 mm
- High PDE (63% at 420 nm)
- Excellent SPTR and CRT
- Excellent uniformity of breakdown voltage
- Excellent uniformity of gain
- Four-side tilable, with high fill factors
- Cell pitch 40 μm
- Highly transparent epoxy protection layer
- Operating temperature range from 0°C to +60°C
- RoHS, CFM, and REACH compliant

### Applications

- X-ray and gamma ray detection
- Gamma ray spectroscopy
- Safety and security
- Nuclear medicine
- Positron emission tomography
- Life sciences
- Flow cytometry
- Fluorescence - luminescence measurements
- Time-correlated single photon counting
- High energy physics
- Astrophysics

# Mechanical Drawing and Pin Layout

Figure 2: Package Drawing with Dimensions

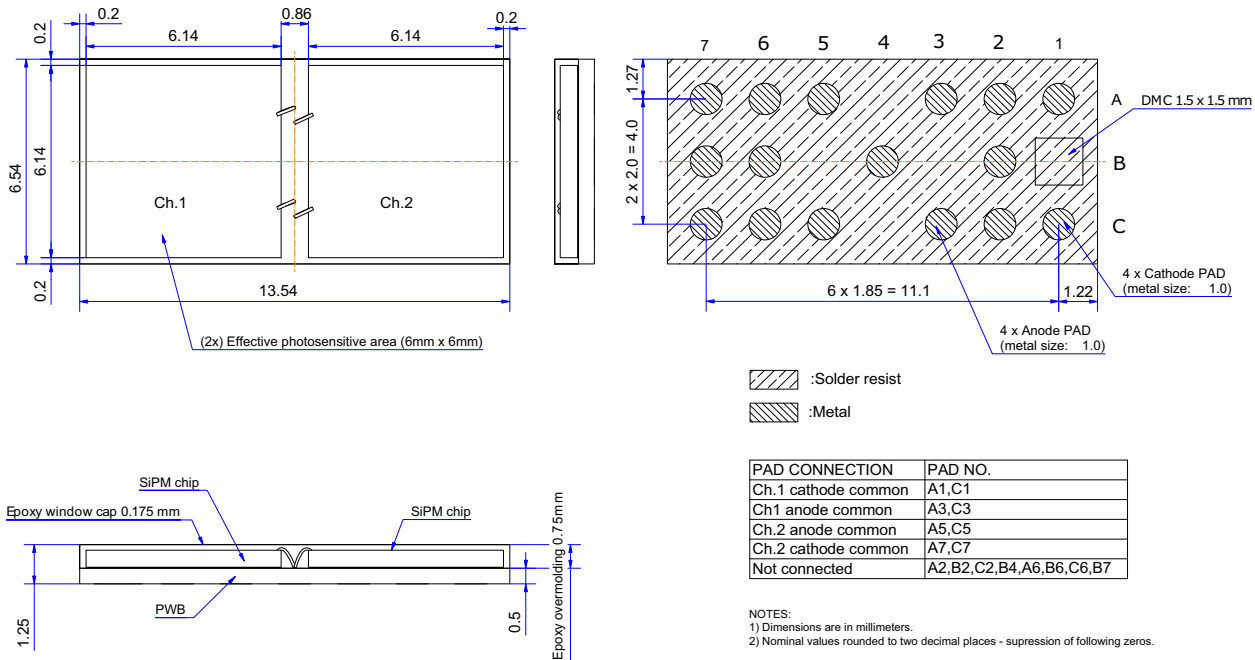
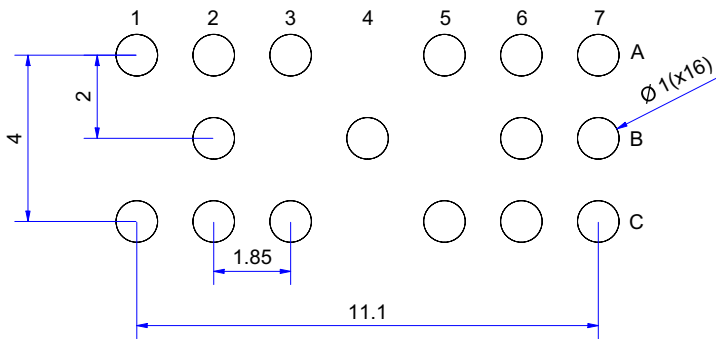

Figure 3: Recommended Landing Pattern Diagram



Note: Dimensions are in millimeters.

## Reflow Soldering Diagram

Figure 4: Recommended Reflow Soldering Profile

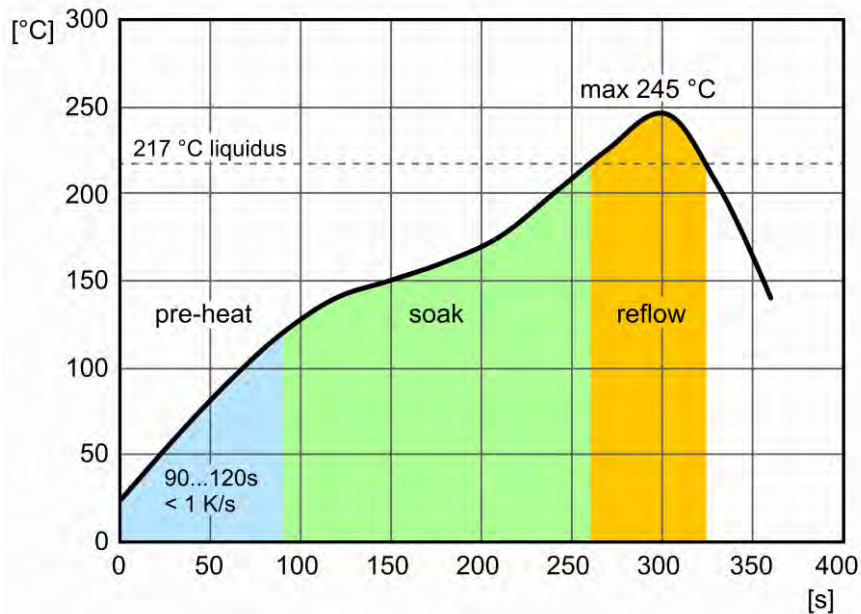

## Absolute Maximum Ratings

Stresses in excess of the absolute maximum ratings can cause damage to the devices. Limits apply to each parameter in isolation. Absolute maximum ratings are those values beyond which damage to the device may occur if these limits are exceeded for other than a short period of time.

Parameter	Symbol	Min.	Max.	Units
Storage Temperature	$T_{STG}$	-20	+80	°C
Operating Temperature <sup>a</sup>	$T_A$	0	+60	°C
Soldering Temperature <sup>b, c</sup>	$T_{SOLD}$	—	245	°C
Lead Soldering Time <sup>b, c</sup>	$t_{SOLD}$	—	60	s
Electrostatic Discharge Voltage Capability HBM	$ESD_{HBM}$	—	2	kV
Electrostatic Discharge Voltage Capability CDM	$ESD_{CDM}$	—	500	V
Operating Over Voltage	$V_{OV}$	—	16	V

a. Biased at constant voltage = 12V above breakdown.

b. The AFBR-S4N66P024M is reflow-solderable according to solder diagram as shown in [Figure 4](#).

c. Baking at 125°C for 16 hours is mandatory prior to soldering. MLD is according to MSL 6 with a floor life of 4 hours at 30°C and 60% relative humidity.

## Device Identification

Each device can be identified and tracked by a unique data matrix code (DMC) on the back of the PCB. The code is structured as follows: YYWWNNNNNN (Y – year, W – week, N – running number). An example DMC is shown in [Figure 5](#).

Figure 5: Example Data Matrix Code for Device Identification



## Device Specification

Features measured at 25°C unless otherwise specified.

### Geometric Features

Parameter	Symbol	Value	Units
Device area	DA	13.54 × 6.54	mm <sup>2</sup>
Total active area	AA	6 × 6 × 2	mm <sup>2</sup>
Element active area	EAA	6 × 6	mm <sup>2</sup>
Micro cell pitch	L <sub>cell</sub>	40	µm
Number of micro cells per element	N <sub>cells</sub>	22428	—

## Optical and Electrical Features

Values are measured at 12V above breakdown.

Parameter	Symbol	Min.	Typ. <sup>a</sup>	Max.	Units	Reference Plots
Spectral range	$\lambda$	360	—	900	nm	<a href="#">Figure 6</a>
Peak sensitivity wavelength	$\lambda_{PK}$	—	420	—	nm	<a href="#">Figure 6</a>
Photo detection efficiency	PDE at $\lambda_{PK}$	—	63	—	%	<a href="#">Figure 7</a>
Dark current per element	$I_D$	—	8.6	—	$\mu A$	<a href="#">Figure 8</a>
Dark count rate per unit area <sup>b</sup>	DCR/mm <sup>2</sup>	—	125	—	kcps	<a href="#">Figure 9</a>
Dark count rate per element	DCR	—	4.4	—	Mcps	<a href="#">Figure 9</a>
Gain	G	—	7.3	—	$\times 10^6$	<a href="#">Figure 10</a>
Optical crosstalk <sup>c</sup>	$P_{Xtalk}$	—	23	—	%	<a href="#">Figure 11</a>
Afterpulsing probability	$P_{AP}$	—	< 1	—	%	
Recharge time constant	$T_{fall}$	—	55	—	ns	<a href="#">Figure 12</a>
Breakdown Voltage	$V_{BD}$	—	32.5	—	V	<a href="#">Figure 8</a>
Nominal terminal capacitance per element <sup>d</sup>	$C_T$	—	1550	—	pF	
Temperature coefficient of breakdown voltage (23...27°C)	$\Delta V_{BR}/\Delta T$	—	30	—	mV/°C	
Temperature coefficient of gain (23...27°C) <sup>e</sup>	$\Delta G/\Delta T$	—	1.46	—	$\times 10^4/^\circ C$	

- Typical values are measured at 12V above breakdown
- Measured at 0.5 p.e. amplitude. Measurement does not include delayed correlated events.
- Calculated as the sum of direct, delayed crosstalk, and after-pulsing probabilities.
- Measured at 40V using input sine wave with  $f = 200$  kHz and  $V_{in} = 500$  mV.
- Calculated from gain dependence on V and breakdown voltage temperature coefficient:  $\Delta G/\Delta T = \Delta G/\Delta V \times \Delta V_{BR}/\Delta T$ .

# Reference Plots

Typical features measured at 25°C unless otherwise specified.

**Figure 6: PDE vs. Wavelength at 12V OV**

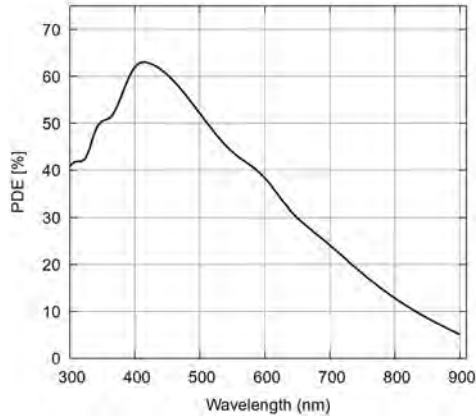

**Figure 7: PDE vs. OV at 420 nm**

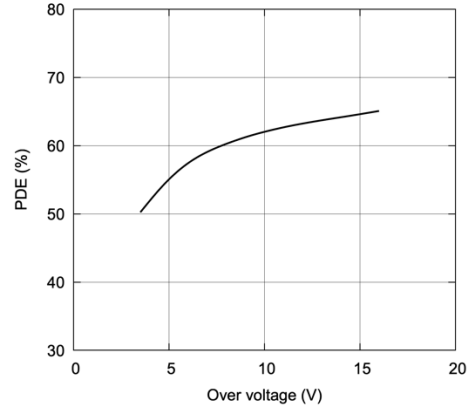

**Figure 8: Reverse IV Curve in Dark Conditions**

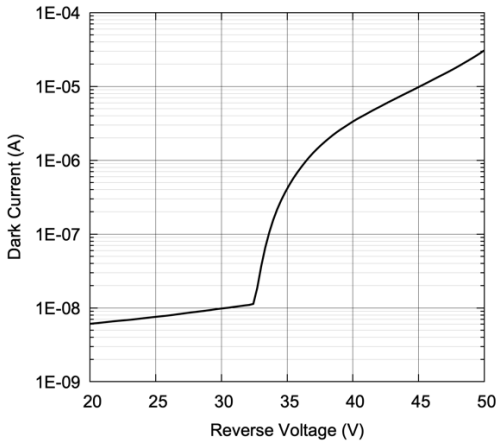

**Figure 9: Dark Count Rate vs. Overvoltage**

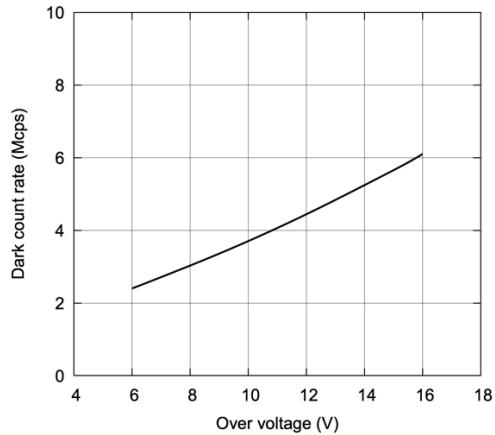

**Figure 10: Gain vs. Overvoltage**

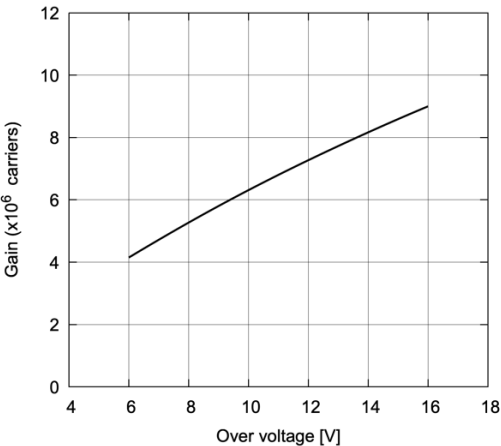

**Figure 11: Total Correlated Noise vs. Overvoltage**

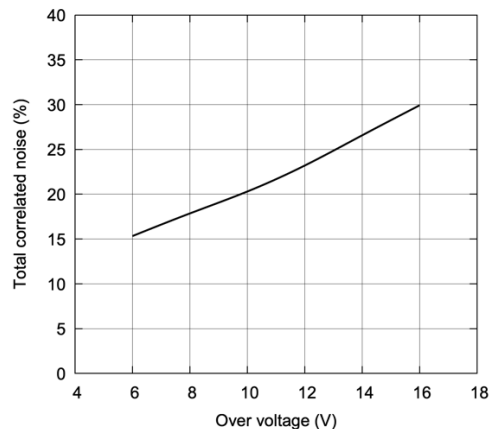

**Figure 12: Typical Pulse Waveform in Response of a Picosecond Laser-Pulse on a Load Impedance of 25Ω and Applied Bias of 12V above Breakdown**

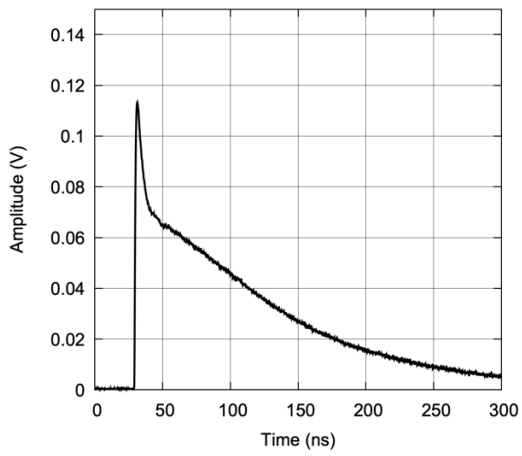

Copyright © 2021–2022 Broadcom. All Rights Reserved. The term “Broadcom” refers to Broadcom Inc. and/or its subsidiaries. For more information, go to [www.broadcom.com](http://www.broadcom.com). All trademarks, trade names, service marks, and logos referenced herein belong to their respective companies.

Broadcom reserves the right to make changes without further notice to any products or data herein to improve reliability, function, or design. Information furnished by Broadcom is believed to be accurate and reliable. However, Broadcom does not assume any liability arising out of the application or use of this information, nor the application or use of any product or circuit described herein, neither does it convey any license under its patent rights nor the rights of others.

